



Conservatory Solid Roof System

Create a comfortable living space with our roof conversion solutions for existing and new build conservatories

Ticks
all
the
boxes





Guardian
Warm Roof

The market-leading Guardian Warm Roof is a revolutionary step forward in home improvement – a high performance, lightweight roof system that has been designed to replace your existing glass or polycarbonate roof or be installed as an alternative on your new conservatory.

The Guardian Warm Roof System dramatically transforms your conservatory into an ambient, much needed space that can be used daily, all year round.

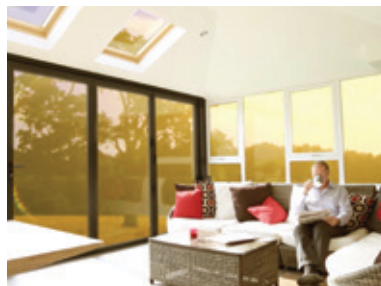

Less sun glare and fading of furniture



Cooler in summer



Less rain noise and 100% weathertight



Warmer in winter

Designed to retain the conservatory's original windows, doors, frames and walls, the Guardian Warm Roof System is fully tested and approved to all thermal and structural standards.

Ridge cappings to match roof tiles or slates

Choice of roof tiles or slates in a range of colours

Standard rainwater systems

Breathable waterproof membrane

Exterior grade plywood

Structural pre-engineered frame

Ventilated roof eliminates condensation and mould growth

3 layers of high performance rigid insulation board (125mm) U-value 0.18 W/m.K (England & Wales) and 0.15 W/m.K (Scotland)



To find out more watch the video at www.guardianroof.co.uk

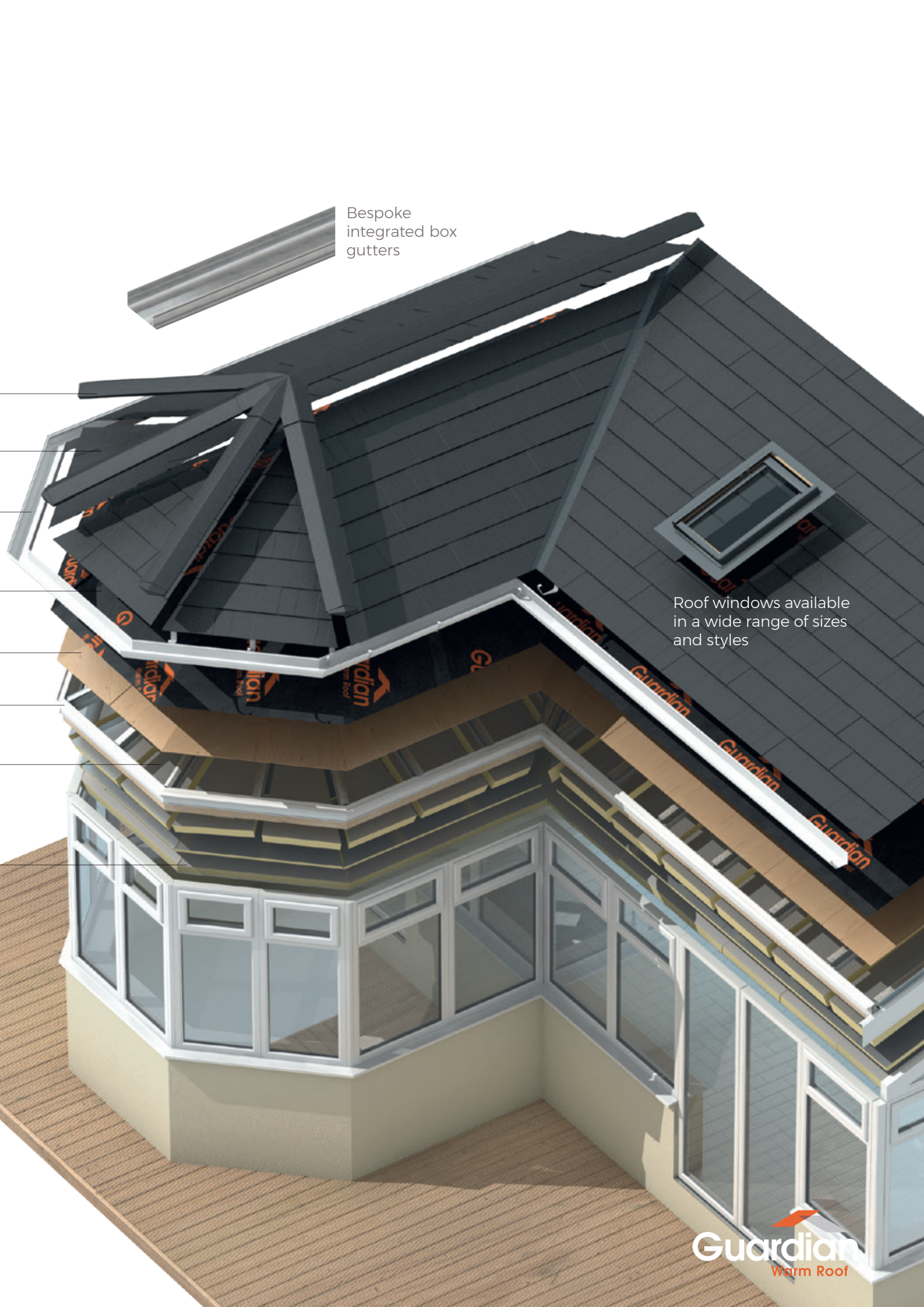

Bespoke
integrated box
gutters

Roof windows available
in a wide range of sizes
and styles

Ensuring your peace of mind



Question

Will my conservatory be able to take the weight of the Guardian Roof?

Answer

The Guardian Warm Roof System has been specifically designed to weigh no more than a glazed roof and is fully tested and approved by industry experts for its structural performance. In addition, the results have enabled certification by the LABC (England & Wales) and the LABSS (Scotland).

The Guardian roof is designed and engineered to replace the entire existing roof. Some conversion systems only overclad the existing roof which was never designed to carry additional weight.

Conservatories have reinforcing posts to take the weight of glazed roofs. Conservatories built before 1996 may not have sufficient support. The Guardian survey will determine the suitability and, where required, will provide a structural solution to support the Guardian Roof.



How can Guardian guarantee the thermal performance of the warm roof system?

The Guardian Warm Roof System has been subjected to independent thermal analysis that takes into account the entire roof assembly, including cold bridging, to give a true U-value as required by Building Regulations. Cold bridging has a major impact on U-value and, if not taken into account, will reduce thermal performance.

Many roof conversions state similar U-values or better, but these are theoretical unless the entire assembly has been thermally tested. If in doubt, ask!

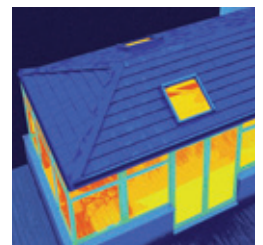



Why is the Guardian Roof structural frame made from aluminium?

After months of testing the Guardian Roof with various materials, a superior lightweight aluminium frame was chosen due to its high-performance structural properties.

Many roof systems use timber, which weighs significantly more, putting additional stress on the existing conservatory walls. Timber is also prone to shrinkage and is often cut to size on-site unlike the Guardian Roof structural frame which is manufactured and pre-assembled under quality controlled factory conditions.

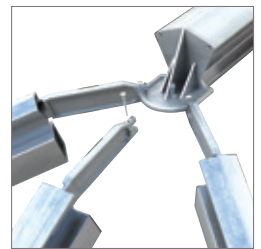

I've read reports of condensation and mould with these types of roof – how is Guardian different?

In compliance with LABC / LABSS, the Guardian Roof is a ventilated roof. Slots in the ring and ridge beams allow air to flow freely through the roof allowing any moisture to exit.

With many unproven roof conversions, moisture can form inside the roof causing staining and mould growth to the internal plasterboard, leading to deterioration or even failure of the roof components.



Will I need to apply for Building Regulations for the new roof?

Under certain criteria, the Guardian Warm Roof System would be exempt from Building Control approval – however, we strongly recommend that approval always be sought.

But, as the Guardian Warm Roof System carries LABC / LABSS certification, the Building Control process should proceed faster, smoother and without complication.

Due to the high performance insulation and with Building Control approval, the Guardian Warm Roof System, may allow the removal of the wall between the house and conservatory, providing the flexibility to extend and enlarge an existing kitchen, living room or bedroom.



System Benefits



Rapid Installation

Installed by one of our Team Guardian Registered Installers, the whole conservatory roof installation only takes a few days and is completed with minimum disruption to your home.



Engineered for Quality

Each Guardian roof is engineered precisely to your individual requirements and pre-assembled under controlled factory conditions to ensure the highest quality before delivery to site.



Energy Efficient

It has been independently proven that a Guardian Warm Roof can save you money on your energy bills, using high performance insulation that achieves a superior U-value of only 0.18 W/m.K (England & Wales) and 0.15 W/m.K (Scotland).

“With Building Control approval, internal dividing doors or walls can be removed to provide an open-plan living space.”



Reduces Noise & Sun Glare

Your new room will be quiet and comfortable all year round as any rain / weather noise will be eliminated.

The Guardian roof also significantly reduces sun glare, which in turn prevents sun bleaching to fixtures and fittings, removing the need to fit blinds to the windows of your conservatory.



Temperature Control

A Guardian Warm Roof regulates the temperature of your conservatory to ensure it's a pleasant temperature whatever the season.

The high-performance insulation guarantees lifetime thermal performance, ensuring your room is economical to heat.



Complete Peace of Mind

The Guardian roof is a superb system and is LABC and LABSS approved.



We provide both standard and bespoke Warm Roof solutions



Edwardian

The Classic Sunroom shape. Together with attractive roof windows the Edwardian Guardian Roof is the traditional option for styling and convenience, maximising the room space below. Sympathetic to all house styles, the ridge of the roof is so versatile it can also be the perfect solution to a Bungalow extension.

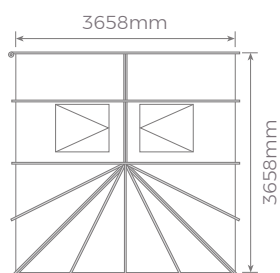
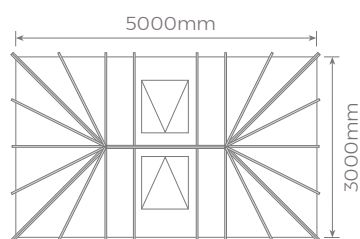

Lean-to

The Guardian Lean-To is ideal to maximise space at the rear of the house. The ends can either have one or two hips (slopes).

Ideal for kitchen extensions, the roof can go as low as 15° with roof windows.

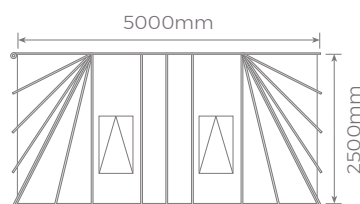
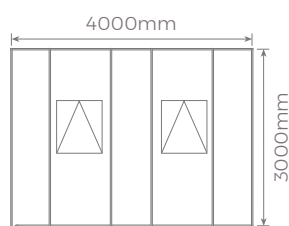

Victorian

The Victorian roof is also ideal if you may not have much available space in your garden.

The internal plaster finish on the roof has an attractive appearance with its facet front finish.

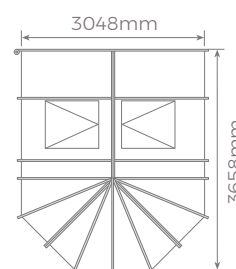



Gable Ended

The gable ended main feature is the continuous height it brings to the room due to its long central ridge.

The gable end allows you to get the most from your roof windows providing a light and airy space.

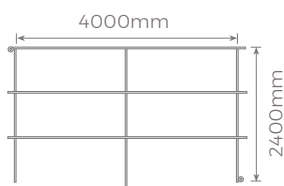

Combination

Increase your options with a combination Guardian Sunroom.

A P-shape simply combines the benefits of two different styles to maximise your living environment. A T-shape combination is available, as well as bespoke solutions to make your conservatory as individual as you are.

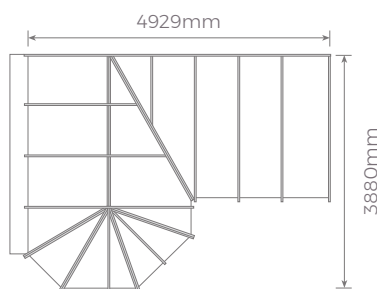

“A Guardian Warm Roof is the ideal solution to replace your existing roof and also as an alternative on all new conservatory installations.”

Roof Tile and Shingle Options



Guardian Esprit Shingle

Exclusive to Guardian, the Esprit Shingle is made from lightweight high grade steel with Aluzinc® coating for incredible strength and resistance and features a unique 'hidden fix' feature that leaves no nails exposed to corrosion.

The choice of colours means Esprit can match or compliment virtually any home.

Charcoal

Scarlet

Coal Black

Greenstone

Burnt Umber

Bister Brown

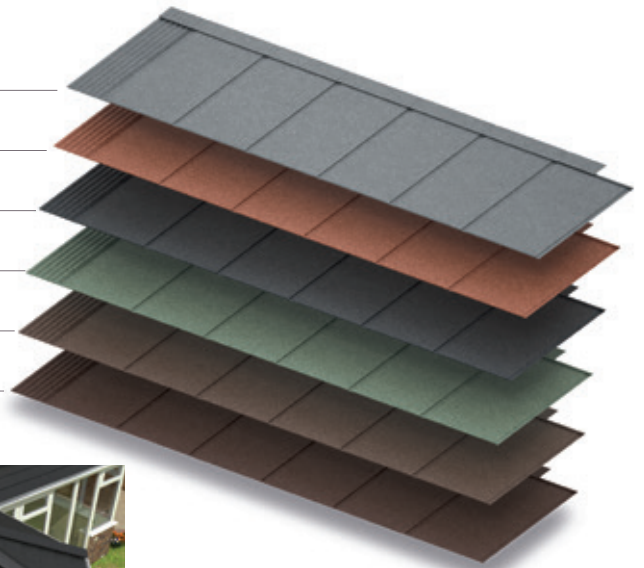

Charcoal



Scarlet



Coal Black

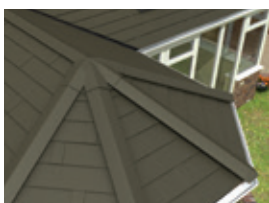

Greenstone



Burnt Umber

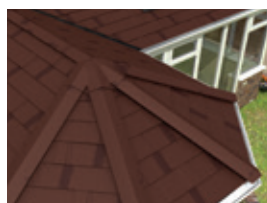

Bister Brown



Guardian Slate

Guardian Slate is an innovative roofing system featuring the aesthetic appeal of natural slate without the risk of cracking and breaking.

Guardian Slate is available in a choice of five natural colours, providing you the opportunity to add texture and style to your home. The colours have been tested to high UV exposure and exhibit virtually no fade and with no trace of cracking or splitting.

Grey

Terracotta

Mulberry

Brown

Black

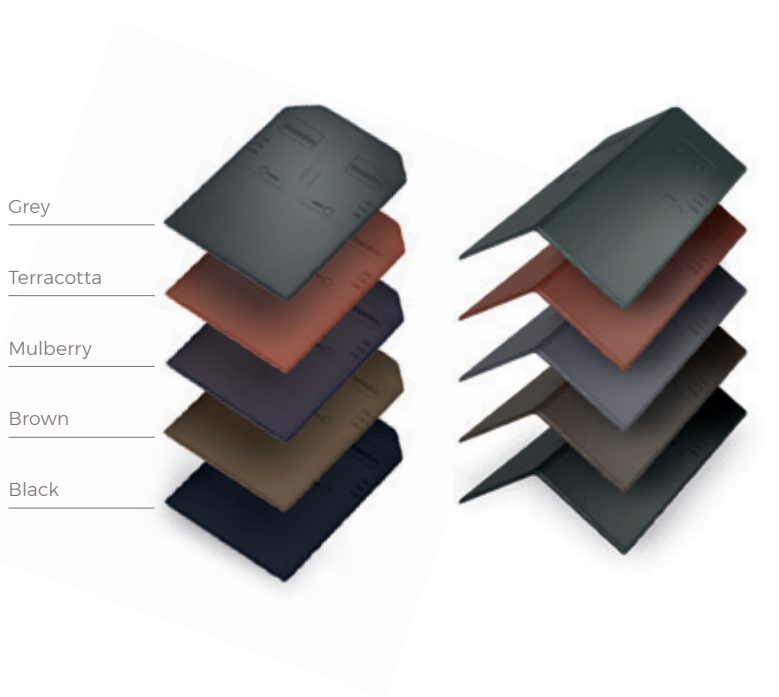

Grey



Terracotta

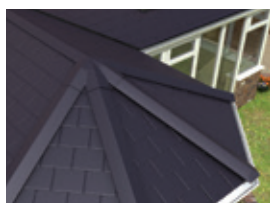

Mulberry

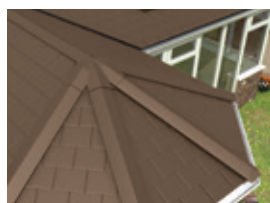

Brown



Black

Lighting Options



Guardian Solstice Rooflight

The new stylish, integrated rooflight system designed specifically for the market-leading Guardian Solid Roof System.

- ◆ High performance sealed glazing unit requiring little or no maintenance
- ◆ Introduces increased levels of natural light into the living space
- ◆ Flush fitting, cost-effective alternative to conventional opening rooflights
- ◆ Extremely easy to fit with the Guardian Solid Roof System



Guardian Solstice Rooflight System Detail

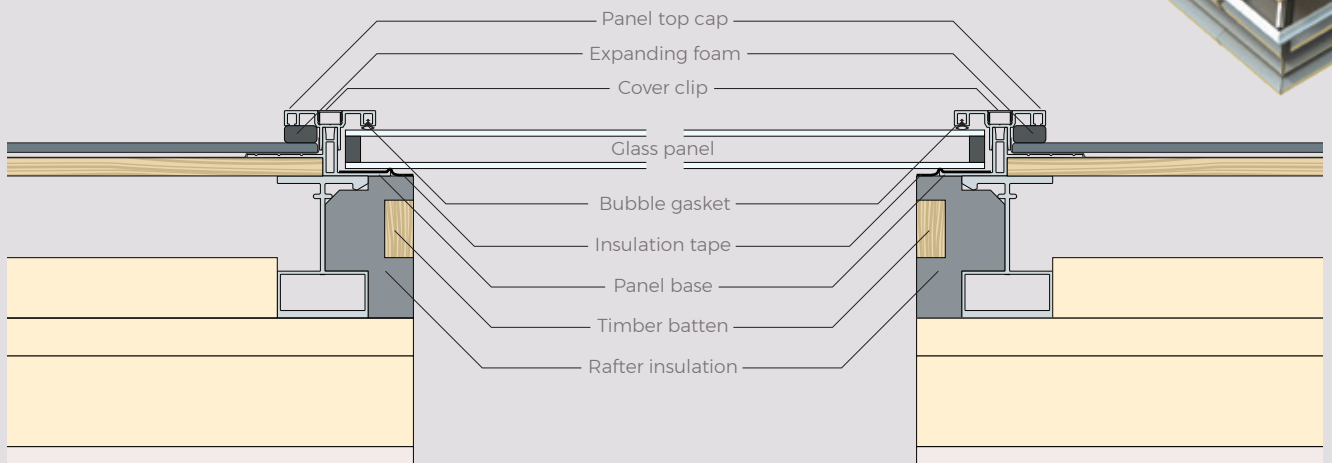



Guardian Downlight

These top of the range downlights require no ventilation, the ultra slim design makes it ideal for low void depths so they are the perfect solution for the Guardian Solid Roof.

They are fitted without the need to penetrate the 25mm insulation layer and vapour barrier eliminating any drafts. The LED unit produces little heat so will not overheat in the cavity.

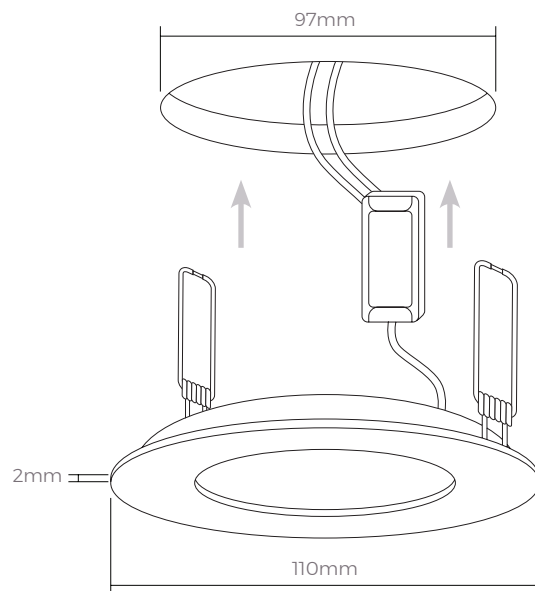

Downlight Technical Specification			
Light Source	LED	Beam Angle	120 Degrees
Dimmable	Yes	Weight	0.37 kg
Max Wattage	9W	Diameter	110mm
Lumens	460	Projection	2mm
Voltage	240	Min Ceiling Void	75mm
Fire Rating	30, 60 and 90 minutes	Finish	Satin nickel or white
Hours	30000	Cut Out	97mm

Dimmer Switch Technical Specification	
JQP401W	White plastic 1-gang 2-way Push-on/off rotary LED Dimmer 1 X 0-120W (1-10 LEDES)
JDSP401S	Matt chrome screwless 1-gang 2-way Push-on/off rotary LED Dimmer 1 X 0-120W (1-10 LEDES)
JQP252W	White plastic 2-gang 2-way Push-on/off rotary LED Dimmer 2 X 0-120W (1-10 LEDES)



Transformed in just a few days...

Typical Build Programme

Day 1

Removal of entire existing roof and installation of Guardian structural frame



The vital first step is to remove the entire existing roof.

Day 2

External weatherproofing allows earlier internal fit-out



Exterior grade plywood is fixed to the rafters.

Day 3

Internal fit-out of high performance insulation and plasterboard



3 layers of high performance insulation (between and over rafters, and insulated plasterboard), is installed.



Timber packer and structural ringbeam are sealed and secured to the top of the window frames.



The aluminium rafters, ridges and wall plates are fitted and the spider arms are secured to the spider bracket.



Breathable waterproof membrane is laid over the plywood and secured in place.



Chosen tile is added ensuring weathertightness and the gutter and external trim are secured in place.

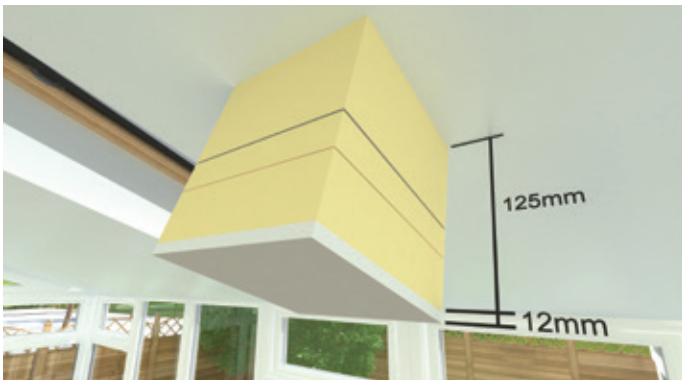

A total of 125mm insulation is used for outstanding insulating performance.



Visit www.guardianroof.co.uk to watch the video.



The Guardian Service Package

Get it right first time

Building work of any kind can be a daunting process.

The Guardian Service Package is the hassle-free way to achieve the roof conversion you want. We will manage your project and keep you informed at every stage, providing a seamless process from your original enquiry, through planning permission to final installation and certification.

Customer journey

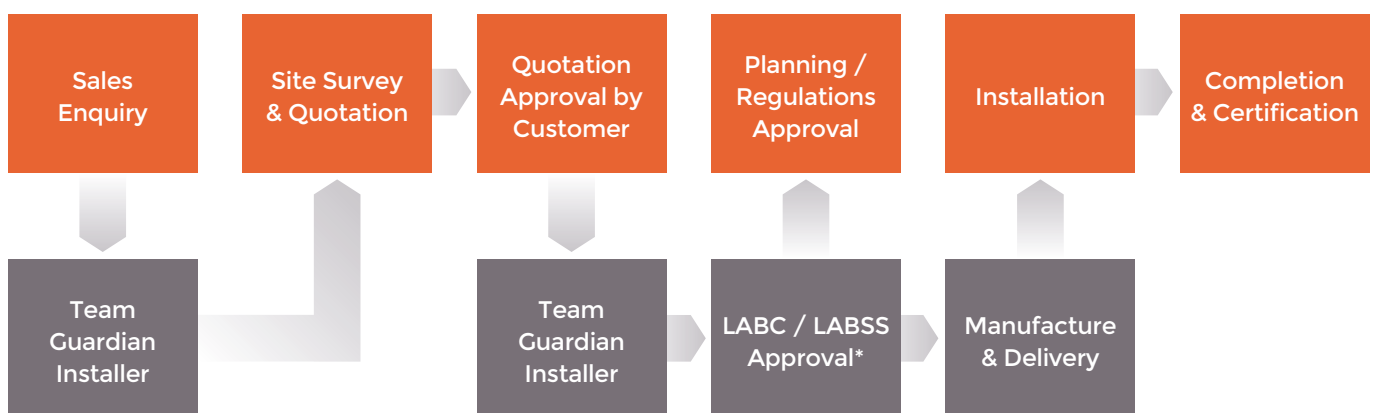

5 Weeks

*LABC / LABSS approval may be necessary. Please consult your Team Guardian Installer.

Team Guardian

UK Approved Installer Network

The Guardian Warm Roof System is manufactured in the UK and there are over 200 companies nationwide who are registered Team Guardian members, fully authorised to install this unique product.

Simply ask to see their Team Guardian ID and you will be assured that your installer is trained, qualified and approved by us. The system has been designed to give you additional assurances, not just for the roof itself but also for the quality of the installation.

Make sure it's Team Guardian!



“There are more than 200 approved Team Guardian installers across the UK.”

Gallery



“ We couldn't really afford an extension but we wanted a conservatory that we could enjoy all year round, so when we heard about the Guardian Conservatory - it was an easy decision. One month later, I can only say that it's given us the perfect room. Light, airy, quiet and comfortable. ”





Integrated Solutions from Guardian

Guardian Warm Roof



Conservatory solid roof system

Guardian Room



Next generation home extension

Guardian Slate

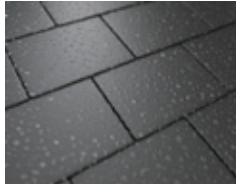

Ultimate lightweight slate solution

Guardian Esprit Shingle



Hidden-fix roof shingle solution

Guardian CleverClick



Luxury vinyl flooring system

RubberLok Safety Tiles



Impact protection flooring

EcoTurf Artificial Grass



Realistic, high quality artificial grass

DuraDek Decking



Low maintenance composite boards

SafetyGrass Rubber Matting

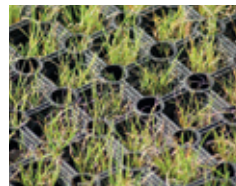

Hard wearing, durable grass protection

RubberLok Utility Mats



Anti-vibration mat for domestic appliances

**Ticks
all
the
boxes**



Guardian Roofs

Freephone: 0800 0665832

Email: info@guardianroof.co.uk

www.guardianroof.co.uk

Whilst Guardian has made every attempt to ensure that this information is accurate and reliable at the time of its publication; we cannot accept responsibility for any errors, omissions, inaccuracies or any changes that have occurred since the date of publication or for the results obtained from the use of such information.

February 2019

**Guardian**
Warm Roof